



MP Antenna, LTD.  
147 Eady Court  
Elyria, Ohio 44035

440.387.5968 phone  
440.545.3500 fax  
www.mpantenna.com  
sales@mpantenna.com

## Model: Omni Directional DAS Indoor/Outdoor Omni Antenna

item part number: 08-ANT-1016  
product description: 700-2700 MHz Omni Antenna

### Electrical Data

frequency range:	700-2700 MHz
gain:	4dBi *
vswr:	<1.8:1
horizontal pattern type:	Omni Directional
vertical patter type:	Full
ground plane:	Built In
min ground plane:	N/A

### Environmental Data

environmental cond.:	Outdoor/Indoor
operation temperature:	-40 to 85 deg C
storage temperature:	-40 to 85 deg C
transport temperature:	-40 to 85 deg C
IP Rating:	IP67
RoHS - REACH	Compliant

### General Data

color:	White or Black
antenna feeds:	one
coax length:	Various
coax type:	Low Loss 200 series
connector type:	Various
polarization:	Multi-Polarized
power:	50 Watts Input
impedance:	50 ohms Nominal
construction:	UV Stabilized ASA

### Mechanical Data

length:	4.7 in
width:	4.7 in
height:	5.7 in
total height:	See Drawing
mounting type:	Stud Mount
hardware included:	Nuts, Washer

**\* With built in spatial and polarization diversity, performance in obstructed environments is greater than that of standard antennas with similar or higher laboratory gains.**



FREQUENCY RANGE	MOUNTING HOLE SIZE	MOUNTING SURFACE MAX THICKNESS	COLOR
700-2700 MHz	Various, Dependent on Connector Type	1.0 Inches	White or Black

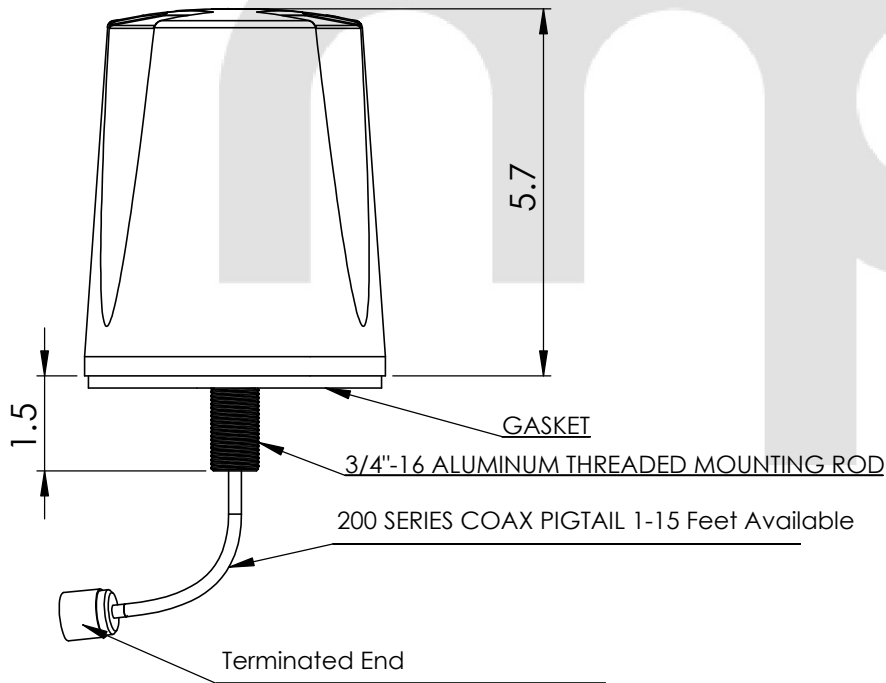
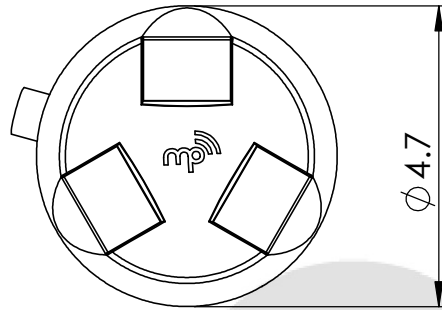
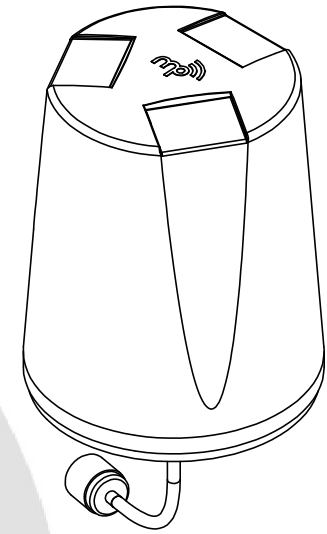

\*Direct N-Female Version Available

### MOUNTING HARDWARE

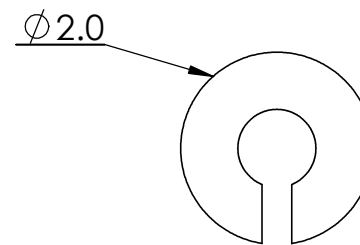

Slotted Washer

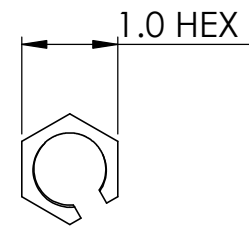

Slotted Nut

MP ANTENNA, LTD.  
147 Eady Court  
Elyria, OH 44035  
www.mpantenna.com

THIRD ANGLE		DIMENSIONS ARE IN INCHES	
	NAME	DATE	
DRAWN	BM	6/8/2020	

**PROPRIETARY AND CONFIDENTIAL**  
THE INFORMATION CONTAINED IN THIS DRAWING IS THE SOLE PROPERTY OF MP ANTENNA, LTD. ANY REPRODUCTION IN PART OR AS A WHOLE WITHOUT THE WRITTEN PERMISSION OF MP ANTENNA LTD IS PROHIBITED.

DESCRIPTION:  
700-2700 MHz  
Omni Antenna

Model NO.  
08-ANT-1016  
Contact Sales for Part Number



MP Antenna, LTD.  
147 Eady Court  
Elyria, Ohio 44035

440.387.5968 phone  
440.545.3500 fax  
www.mpantenna.com  
sales@mpantenna.com

## Model: Omni Directional DAS Indoor/Outdoor Omni Antenna

Item part number: 08-ANT-1016  
product description: 700-2700 MHz Omni Antenna

Frequency: 700 MHz  
Max Gain: 3dBi

Frequency: 800 MHz  
Max Gain: 3dBi

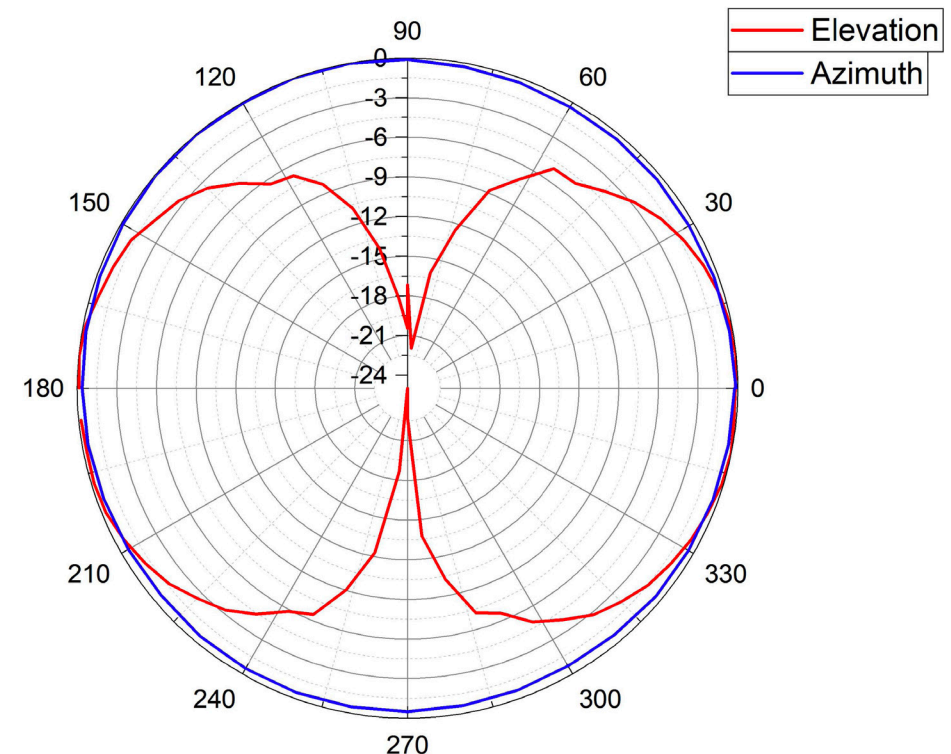
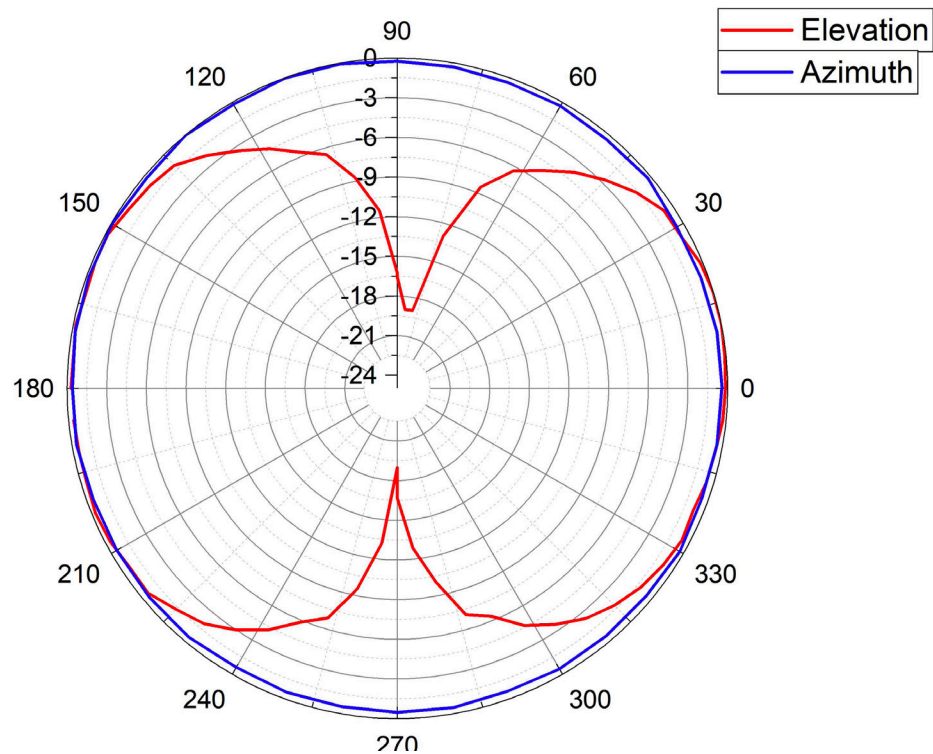



MP Antenna, LTD.  
147 Eady Court  
Elyria, Ohio 44035

440.387.5968 phone  
440.545.3500 fax  
www.mpantenna.com  
sales@mpantenna.com

### Model: Omni Directional DAS Indoor/Outdoor Omni Antenna

Item part number: 08-ANT-1016  
product description: 700-2700 MHz Omni Antenna

Frequency: 900 MHz  
Max Gain: 3dBi

Frequency: 2.0 GHz  
Max Gain: 4dBi

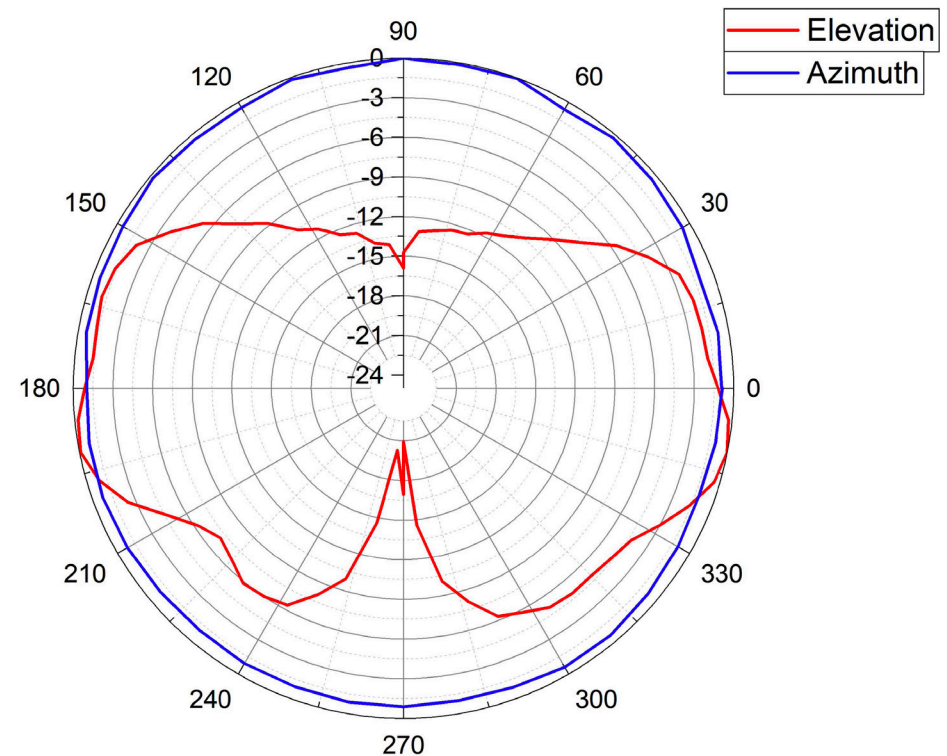
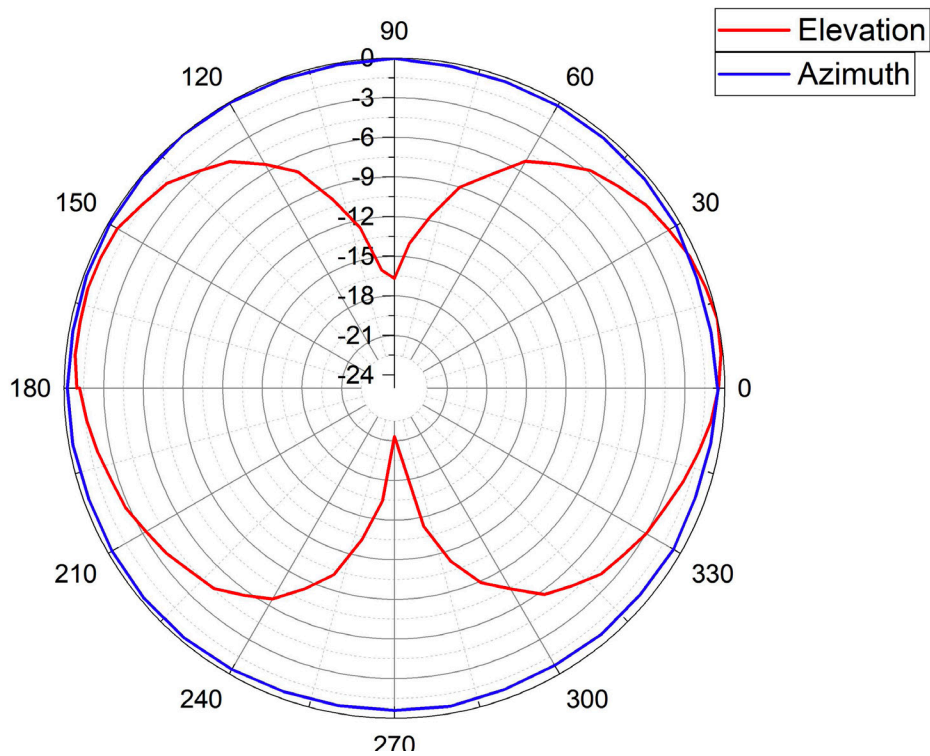



MP Antenna, LTD.  
147 Eady Court  
Elyria, Ohio 44035

440.387.5968 phone  
440.545.3500 fax  
www.mpantenna.com  
sales@mpantenna.com

### Model: Omni Directional DAS Indoor/Outdoor Omni Antenna

Item part number: 08-ANT-1016  
product description: 700-2700 MHz Omni Antenna

Frequency: 2.4 GHz  
Max Gain: 4dBi

